

HADES

SPEAKER ♦ CHARGER ♦ CAMERA



Contents

In the Box	Page 1
Diagram	Page 2
Mobile App Setup	Page 4
Remote Video Stream	Page 9
Advanced Features	Page 10
Camera Name and Password	Page 11
Motion Alarm Notifications	Page 12
Recording Locally to Memory Card	Page 13
Viewing Recorded Media	Page 15
Bluetooth Speaker Setup	Page 16
Troubleshooting	Page 17
Formatting on PC	Page 18
Formatting on Mac	Page 20
Product Specifications	Page 22
Warranty	Page 23
Additional Help	Page 25

IN THE BOX



- A. Speaker Camera
- B. Audio headphone jack cable
- c. Driver CD
- D. Reset Pin
- E. Micro USB adapter
- F. This manual
- g. USB AC Wall Charger

DIAGRAM

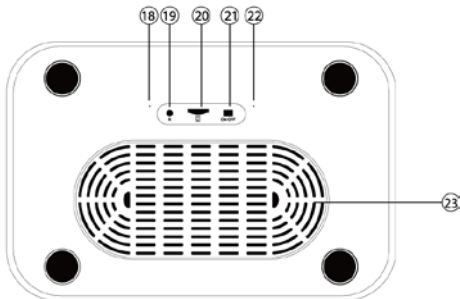
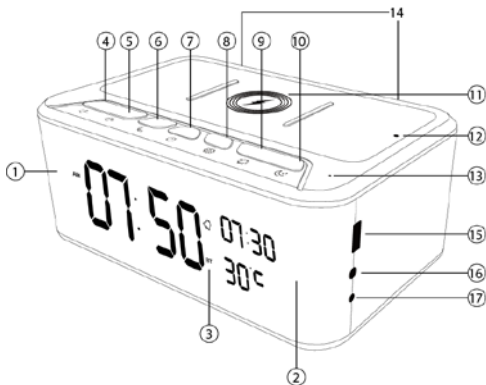

DIAGRAM

- 1 Camera Sensor
- 2 Infra-red emitter
- 3 Bluetooth Indicator
- 4 Lower Volume / Previous
- 5 Increase Volume / Next
- 6 Pause / Pickup phone
Press and hold: Celsius / Fahrenheit
- 7 Bluetooth Speaker On/Off
- 8 Time setup
Press and hold: 12 hour / 24 hour format
- 9 Alarm setup
- 10 Snooze
- 11 Wireless charging platform
- 12 Charging indicator light
- 13 Bluetooth Mic
- 14 Bluetooth Speakers
- 15 USB Charging Port
- 16 Audio Auxiliary Input
- 17 12V DC Power Input Connector
- 18 WiFi Camera Mic
- 19 Reset Button
- 20 MicroSD Card Slot
- 21 WiFi Camera On/Off
- 22 Power Indicator Light
- 23 Speakers

MOBILE APP SETUP

1. Download the App

Download and install the **HDSmartIPC** app from Google Play or the App Store.



Google Play



App Store

2. Power up the device

If your device uses a battery, ensure that it is charged, else ensure that it is connected to power or powered on.

3. Turn on the WiFi

Some devices will have a WiFi switch, if so please identify it and make sure it's turned on.

4. Connect to the device camera's WiFi

Open your smartphone settings, search and connect the to device's wireless network name starting with the letters "LM..." or "AI...", wait for Wi-Fi to connect, and phone status bar to shows the Wi-Fi symbol  in blue.

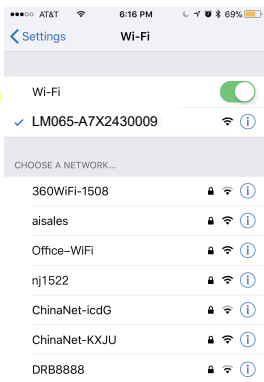

MOBILE APP SETUP

5. Connect the phone to the camera device.

Enter the App, and the app will add just the connected camera automatically.

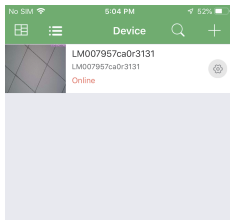

if you dont see any listed press the plus sign (+) to add a new camera. On the next screen hit **LAN search** device, then you will be shown a list of all detected cameras. You should see at least one. Hit **Add** to add the camera

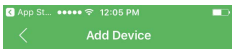

 Scan QR code

 LAN Search

 Add manually

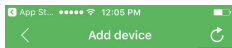

AI0079HHJOIGHH
IP:192.168.1.244



6. Add the camera

Back on the App's main screen you will see a video preview display of the added camera.

Press the gear  icon to open settings then select **Device settings**.

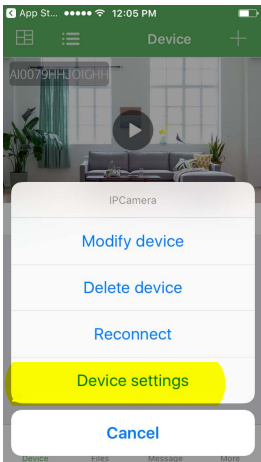
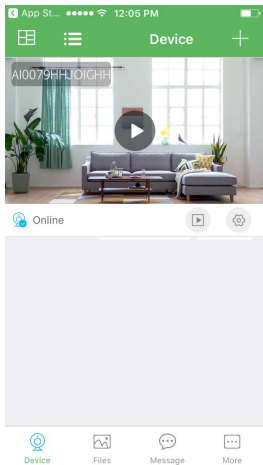

MOBILE APP SETUP

Select **Wi-Fi Config** (**Network configuration** on Android phones) then look for your local WiFi network name (**SSID**). You will be prompted for your local network **Password**. The App will now connect to the camera.

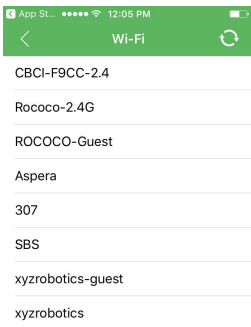
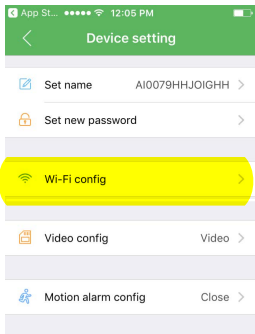

Quit and restart the App, and the device will start up with the WiFi connected within 30 seconds.

You can now go back to your phone settings as in the previous section and connect your phone back to your local Wifi network.

The app will now stream live videos from anywhere as long as your phone has internet access.

LIVE STREAM

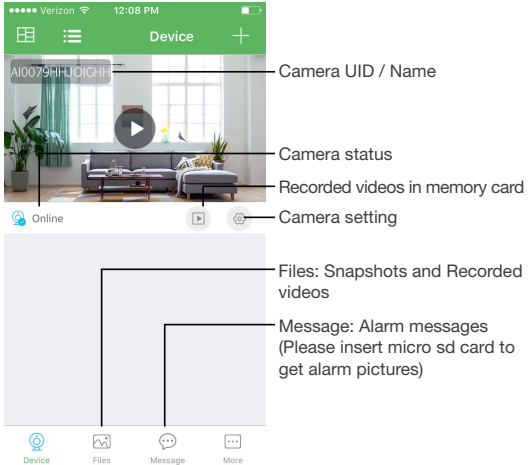

ADVANCED FEATURES

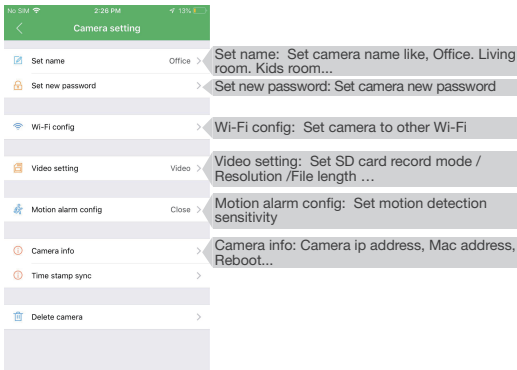

TIPS: Each setting in Device Settings, please scroll down and press ok to save the setting.

CAMERA NAME AND PASSWORD

Hit the gear icon  below the camera view, then select **Modify Device**, you will be prompted to **Set name**, choose a new camera name, then set the **Set new password**.

The Default (old) password is **8888**. Enter your desired password, and hit **OK**.

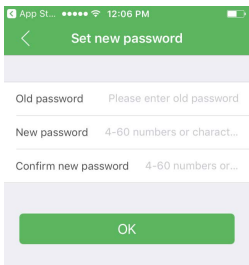
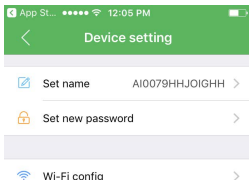
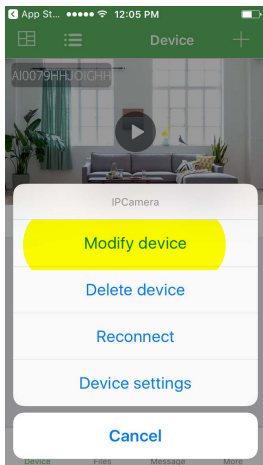

MOTION ALARM RECORDING

Alarm notification will send you a notification and record a snapshot when the camera detects motion. Under **Device settings** choose set **Motion Alarm config** and set Motion detection to ON.

Alarm interval is the time it should continue to record after motion was initially triggered.

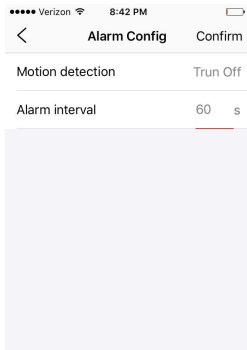
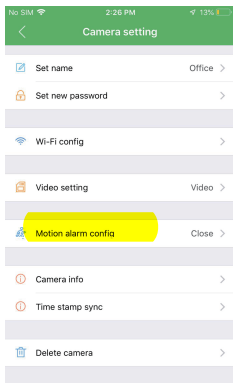

To record the video on Alarm, please refer to the **Alarm video** on the next section.

LOCAL MEMORY CARD RECORDING

Media can be recorded to a memory card installed on the device. First make sure that you have a MicroSD memory card installed in the CRESENDO.

Hit the gear icon  below the camera view to go into **Device Settings**, then select **MicroSD Card Config** on Android phones and look for TF card set.

You have the option to format the memory card, record at all times, record at specified intervals, or stop the recording.

Recording Length is the maximum video file segments length.

Alarm video will record locally when motion is detected and alert you on your phone. Please refer to the next section on this manual to set up alarm notifications.

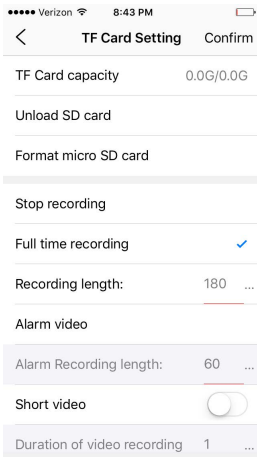

Verizon	8:43 PM	
<	TF Card Setting	Confirm
TF Card capacity	0.0G/0.0G	
Unload SD card		
Format micro SD card		
Stop recording		
Full time recording	<input checked="" type="checkbox"/>	
Recording length:	180	...
Alarm video		
Alarm Recording length:	60	...
Short video	<input type="checkbox"/>	
Duration of video recording	1	...

Format MICRO SD card: this will wipe all media and files recorded on the MicroSD card

Stop record: no recording is done.

Fulltime recording: records indefinitely.

Alarm Video: records when motion is detected. Note that motion activation needs to be set for this to work, please refer to Page 12.

Recording length refers to how long the video files will be segmented into. The HADES records video into file segments of up to 20 minutes in length.

Playback with HDSmartIPC app

You can use the app to review the media recorded to the card; from the main menu, tap on the Files icon on the bottom of the screen.



Playback from computer.

You can also connect the memory card to your computer and view it there. You may have to use the included adapter (E). It will come up as a removable drive and all the files can be accessed by opening the folder.

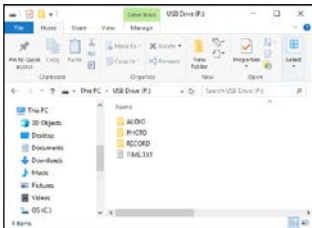

We recommend using the free VLC Media player to play back media in your computer. Download from <http://www.videolan.org>

BLUETOOTH SETUP

Press the Bluetooth Clock power button to turn on Bluetooth **7** on the HADES to start the search.

Under your phone Settings, ensure **Bluetooth** is turned on, wait for it to search then select the **019T** device.

All media played on your phone will be played out though HADES's speaker.

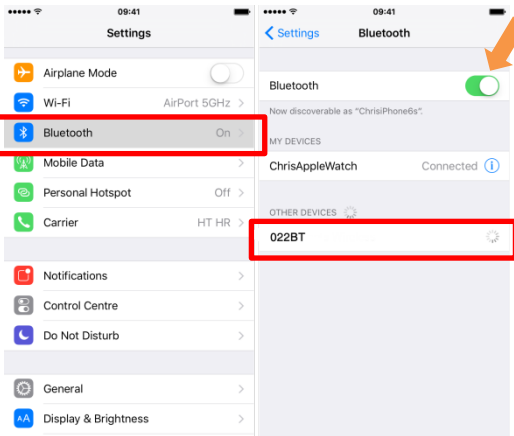

Most issues can be solved by formatting the memory card, restarting the HADES, or resetting the HADES's WiFi.

Formatting the memory:

WARNING: formatting the memory will wipe out all the recorded media previously stored.

Formatting the memory will clean up any file corruption that may exist preventing the device from operating correctly.

Please refer to Page 18 or 20 on how to format the memory card.

Restart the HADES

Restart the app, disconnect the power from the HADES, turn off the power , for about 30 seconds and wait 1 minute.

Reset the HADES's WiFi:

While the power is on, using the included reset pin (D), press and hold the reset switch  for about 10 seconds. You may need to remove the camera from the app, and add it again. See page 6.

Formatting the memory on a PC:

Connect the memory to your PC as instructed on page 15 of this manual.

Locate your hard drive directory. It will be under “My Computer” or “This PC”. You can also open a new File Explorer window and your drives will be listed there. The memory card will appear as a “Removable Drive” or “USB Drive”.

Right Click on the removable drive and select Format.

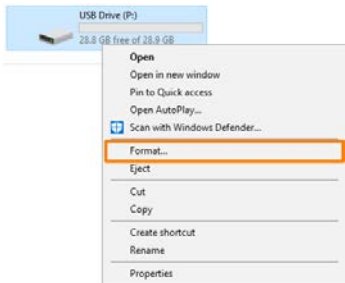

FORMATTING ON A PC

From the options shown, make sure that you have selected FAT32 or exFAT as your file system. Leave other settings at their defaults.

Click Start. After a few seconds the memory will be formatted.

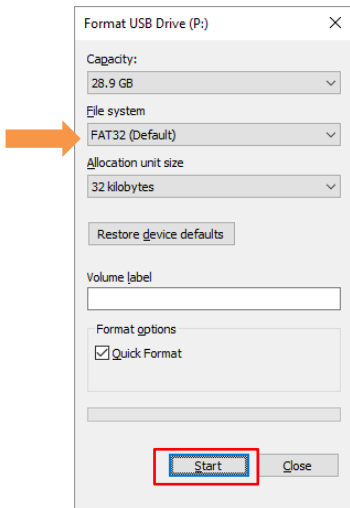

Formatting the memory on a Mac

Connect the memory card to your computer as instructed page 15 of this manual.

Locate and open a program called “Disk Utility”. It is usually found by going into the application folder and opening the utility folder.



App Locations -> Utilities

FORMATTING ON A MAC

In Disk Utility, Select the drive from the list on the left. Most likely named “NO NAME”.

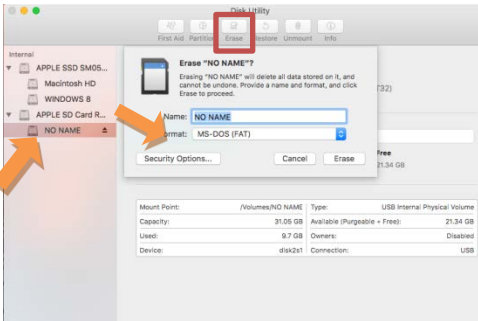

Along the top of the window menu, click on the button labeled **Erase** (highlighted in the square above)

From the dropdown menu labeled Format, choose **MS-DOS (FAT)**.

When ready, click the button in the lower right corner labeled **Erase**.

After a few seconds the memory will be formatted.

PRODUCT SPECIFICATIONS

Item	Parameter
Sensor	2 Megapixel CMOS
Video Resolution	1920x1080
Video Format	H.264
Frame Rate	Up to 25 FPS
Viewing Angle	120 degrees
Night vision	Up to 20 Feet
Power Adapter	12V/2.5A
Memory Capacity	128GB MicroSD
Recording rate	20MB per Minute
Mobile OS Support	Android / iOS
Desktop OS	Winsows 7,8,10/Mac OS X

1 Year Limited Warranty

Zetronix Corporation ("Zetronix") warrants this product against defects in material or workmanship as follows: **PRODUCT:** Zetronix will repair this product with new or refurbished parts, free of charge, for a period of one (1) year from the date of original purchase in the event of a defect in materials or workmanship. **REPAIRS:** Zetronix will repair or replace defective parts used in the repair or replacement of this product with new or refurbished parts, free of charge, for a period equal to the remainder of the original limited warranty period on the original product, or for 60 days after the date of the repair or replacement, whichever is longer. This warranty is extended only to the original purchaser. Proof of purchase in the form of a bill of sale or receipted invoice, which is evidence that the unit is within the warranty period, must be presented to obtain warranty service. To obtain warranty service, you must take this product, or deliver the product freight prepaid, in either its original packaging or packaging affording an equal degree of protection, to Zetronix Corporation. See below for additional information. This warranty only covers failures due to defects in materials and workmanship, which occur during normal use.

The warranty does not cover damages, which occurred in shipment, cosmetic damage, damage that is attributable to acts of God, failures which are caused by products not supplied by the warrantor, or failures which result from accident, misuse, abuse, neglect, mishandling, faulty installation, misapplication, improper installation, operation or maintenance, alteration, modification, introduction of sand, humidity or liquids, line power surge, improper voltage supply, lightning damage, or subjecting the product to operating/environmental conditions in excess of the maximum values or below the minimum values set forth in the applicable specifications, or products serviced by anyone other than Zetronix. This warranty is invalid if the factory-applied serial number has been altered or removed from the product. This warranty does not cover products sold AS IS or WITH ALL FAULTS. This warranty excludes consumable parts such as batteries and power supplies. Zetronix Corporation ("Zetronix")

warrants this product against defects in material or workmanship as follows: **PRODUCT:** Zetronix will repair this product with new or refurbished parts, free of charge, for a period of one (1) year from the date of original purchase in the event of a defect in materials or workmanship. **REPAIRS:** Zetronix will repair or replace defective parts used in the repair or replacement of this product with new or refurbished parts, free of charge, for a period equal to the remainder of the original limited warranty period on the original product, or for 60 days after the date of the repair or replacement, whichever is longer. This warranty is extended only to the original purchaser. Proof of purchase in the form of a bill of sale or receipted invoice, which is evidence that the unit is within the warranty period, must be presented to obtain warranty service. To obtain warranty service, you must take this product, or deliver the product freight prepaid, in either its original packaging or packaging affording an equal degree of protection, to Zetronix Corporation. See below for additional information. This warranty only covers failures due to defects in materials and workmanship, which occur during normal use.

The warranty does not cover damages, which occurred in shipment, cosmetic damage, damage that is attributable to acts of God, failures which are caused by products not supplied by the warrantor, or failures which result from accident, misuse, abuse, neglect, mishandling, faulty installation, misapplication, improper installation, operation or maintenance, alteration, modification, introduction of sand, humidity or liquids, line power surge, improper voltage supply, lightning damage, or subjecting the product to operating/environmental conditions in excess of the maximum values or below the minimum values set forth in the applicable specifications, or products serviced by anyone other than Zetronix. This warranty is invalid if the factory-applied serial number has been altered or removed from the product. This warranty does not cover products sold AS IS or WITH ALL FAULTS. This warranty excludes consumable parts such as batteries and power supplies.

Still Have Questions?

**Do not return your
camera**

For additional assistance contact
Zetronix Tech Support

By Phone.....877-644-7592

By Email.....support@Zetronix.com

Live Chat at Zetronix.com
9AM-5PM EST
Monday to Friday

<http://help.zetronix.com>
©2020 Zetronix Corp.