

Wifi

Intelligent Solar Energy Alert PTZ Camera

User Manual



V2.3

1:PRODUCTS & PACKING LIST

1.1 Product picture:



1.2 Packing list:

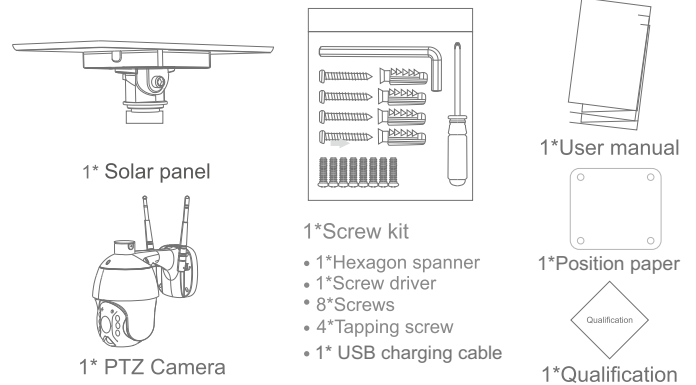

Product Diagram

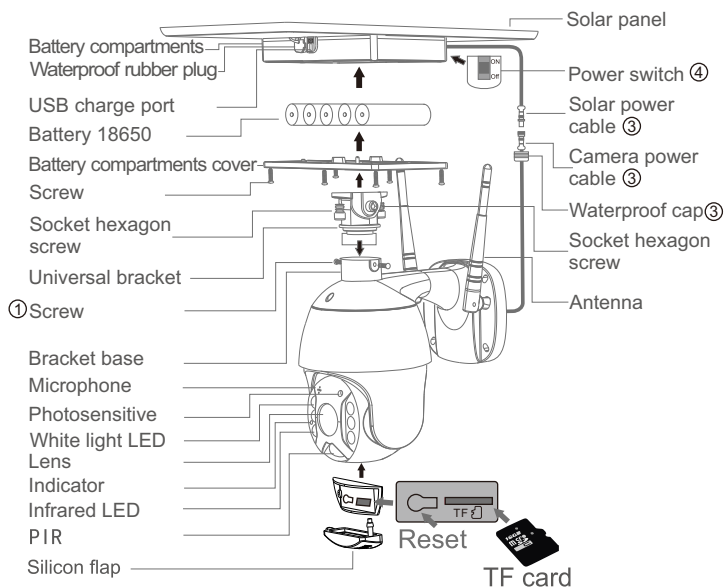

1.3 Process

- 1.3.1. Solar panel: connect panel to camera, fix a suitable angle with screws
- 1.3.2. SD card installation : open the silicon flap and insert the SD card, then make sure to close the silicon flap to avoid rain leakage
- 1.3.3. insert TF card , then tightening the screws.. Power cable: connect the cables between the panel and camera, then tightening the waterproof cap.
- 1.3.4. Panel power-on: Remove the rubber of panel,make sure it is power on. Then put the rubber back to the panel.

2 .INSTALLATION

2.1 Intergrated installation

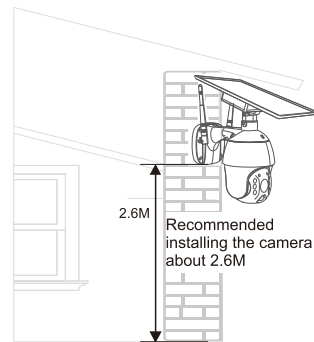

2.2 Separated installation

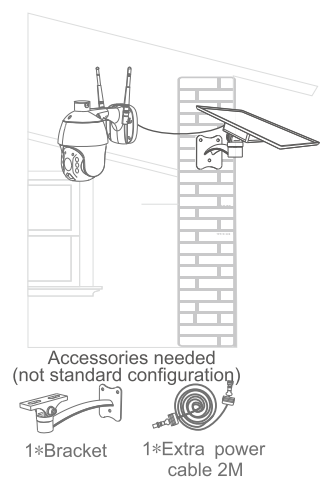

3. APP INSTALLATION

3.1 Search and download " tuya " in major application markets or scan the QR code below to download the APP.



3.1.1 Once you download the APP to your smart phone, you may enter the first page which you can Login with existing account or register.

(If you are the new user of Smart Life and don't have an account, please choose register first and follow the below screenshots to complete the registration.)

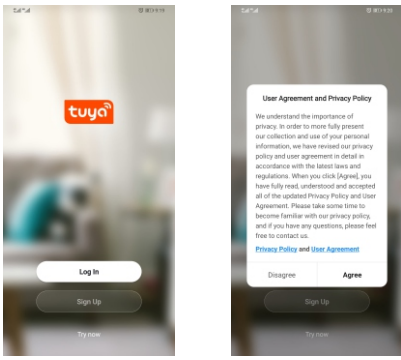

Step1:click "Add Device"or click "+" on top of right on this page.

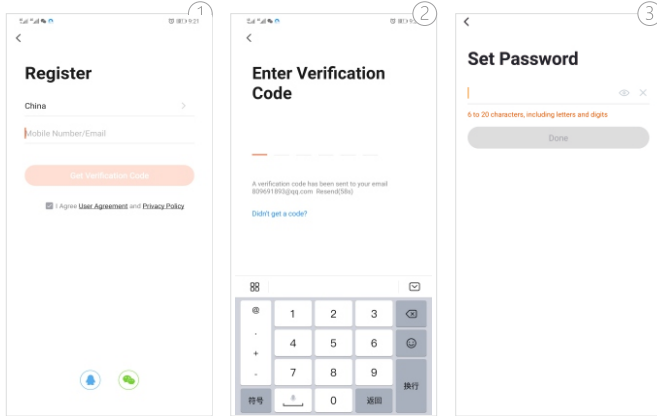
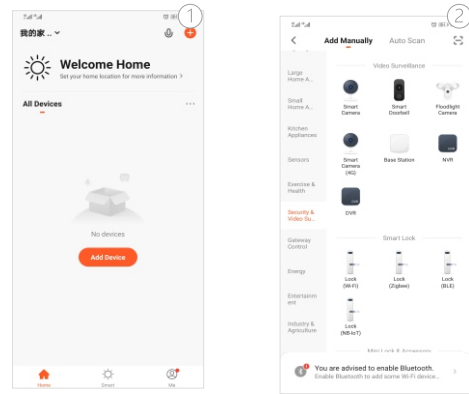

Step2: choose "Security& Sensor"and follow the screenshots below.

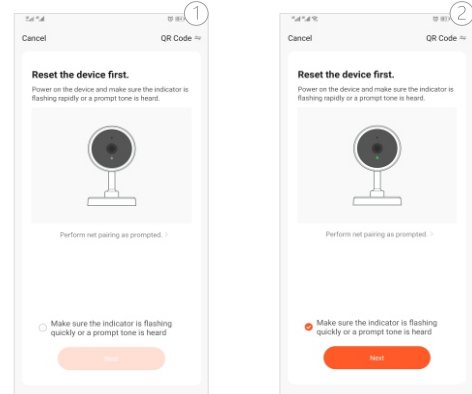

(If you have the existing account, there are two ways to login, one is with SMS verification Code, the other one is with password. In case you forget the password, you may choose login SMS verification Code or you can choose forgot password to reset it by Entering Verification Code which sent to you mobile via message.)

3.1.2 Once the account has been setup successfully, then you will automatically enter the page of "add device", kindly follow below steps to add the camera.

Step3: You may choose next step to go to QR code paring mode or you may go to "other Mode"on top of right to enter the page of choosing QR Code Net-pairing or Smart configuration, if you choose the "next step",you may follow the below screenshots:

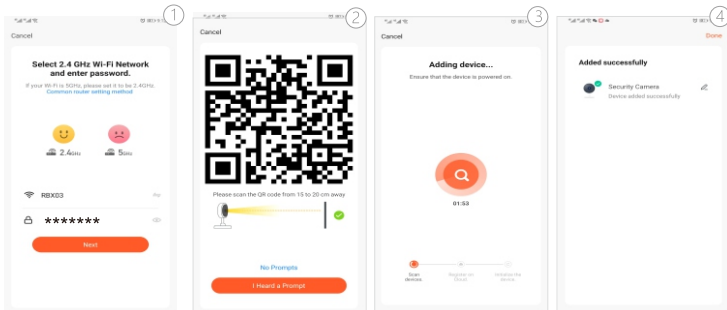

Step4. If you choose " the other mode " on the top of the right side, you may find QR Code Net-pairing Which you will go back to the "Add device"page and process it again like above procedure. Or you can choose "Smart configuration"and follow the below screenshots and after that you will see the device added successfully.

4.FAQ:

After the configuration is done, our device will be showed on Smart Life APP which enable you to surf the smart living easily. If you have any questions about App using, you may go to category "me"to find the " Help Center"and check if you have the same issues. If not, you can report the issue and then your problems will be handled and answers will be given soon if you provide as much information as you can.

5.Safe Battery Handling and Usage

DO NOT allow the batteries or battery compartment to get wet prior to or during installation while your Wire-Free camera is weatherproof and safe to use outside.

