



QUICK START GUIDE

Soliur-XZ5-Dual-Pro-WIFI

4K Wi-Fi Dual Lens Solar Powered Rotating Security
Surveillance Camera



1.What's Included

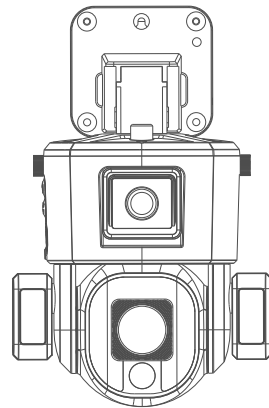

1 Camera

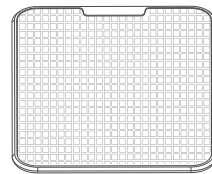

2 Solar Panel

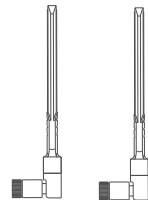

3 Antenna-A 4 Antenna-B

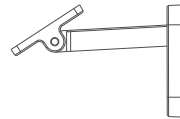

5 Solar Panel Bracket



6 TYPE-C Charging Cable



7 Hexagon Wrench



8 Iron Wall Bracket

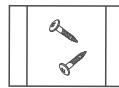

9 Screw Packs

2.Product Overview

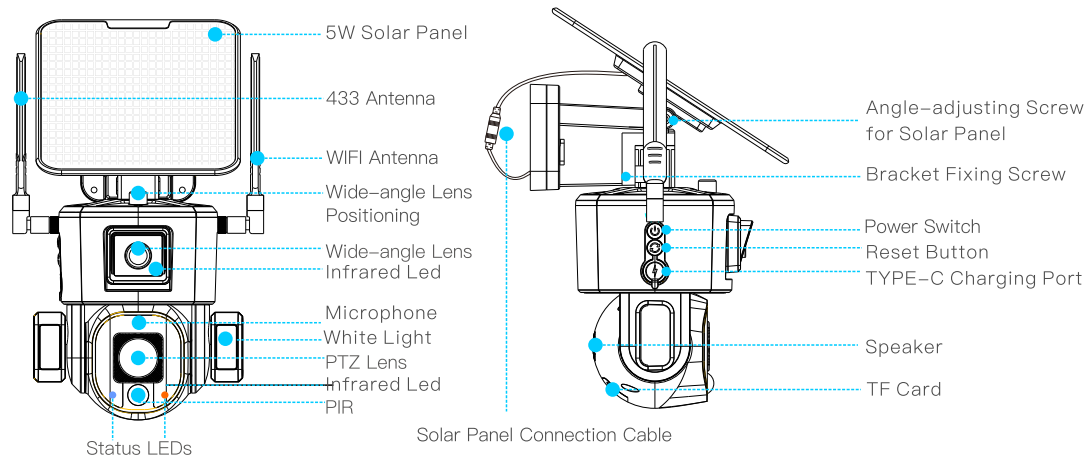

3.Application Scenarios

No power supply required, please move the solar panel toward the maximum sunlight orientation. Install the camera according to the environment, wide-angle lens for monitoring overall situation, PTZ lens for watching details. You can view and control the two displays at the same time that realize wiring-free, one machine in multi-degrees of no dead angle monitoring.

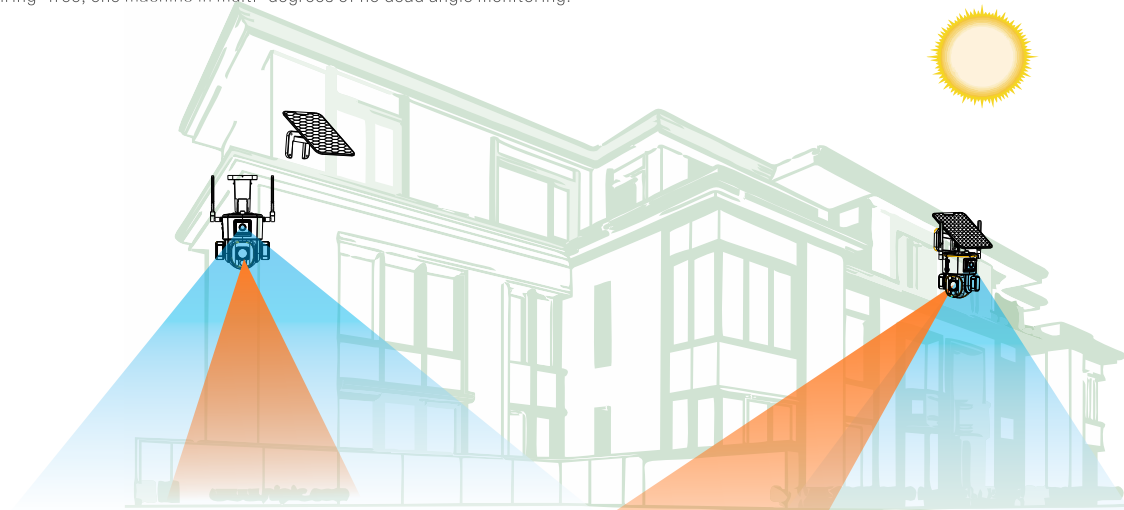

4.Boot Instructions

- 1 Install the antennas in sequence, Take notice of installing the corresponding A and B antenna.
- 2 For a better use, charge the camera preferably for 10 hours before use.

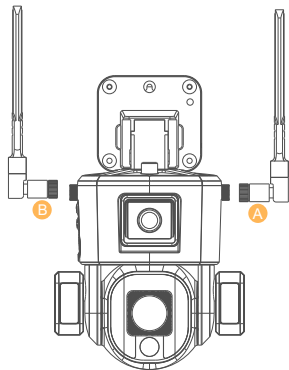

- 3 Connect the solar charging cable, switch on the power, power button is self-locking switch, one press to turn on the power, one more press to turn off the power, after switch on the power, Tapping and holding the reset button for 5 seconds, ready to match the network.

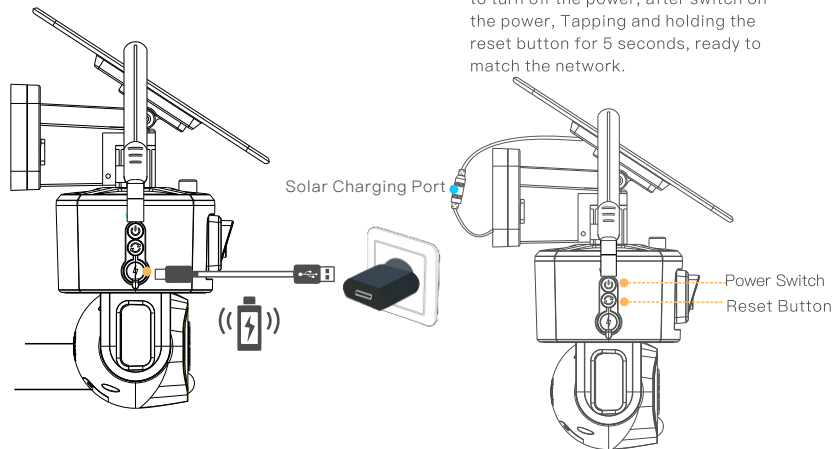

5.Download APP & Register

1.Download APP

Download the APP NIVIEW from App Store(IOS devices) or Google Play(Android device).



APP.NICEVIEWER.COM

Scan the QR code or visit website to download the APP.

2. Register

To better user experience and equipment protection, we suggest that first-time user choose verification code mode to register, use Email to register your account by APP and set the password for your confidentiality. Account and password to login.

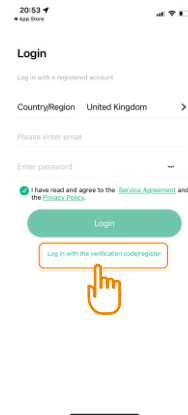

6. Configuration and Addition of WiFi Devices

3. Add Camera

Run the app, click the upper right corner “+” to add.

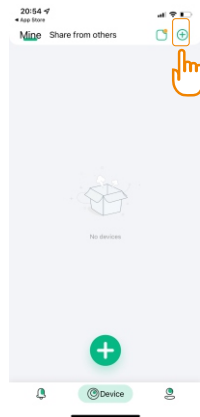

4. Choose Network Type

Select the WiFi option on the left.



5. Confirm Camera Status

Follow the prompts to determine whether the indicator light on the front of the camera is flashing alternately in red and blue. If the indicator light flashes red and blue alternately, just click "To connect".

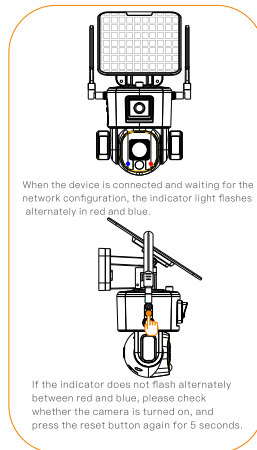

6. Enter Network Information

Click Switch WiFi to select your home WiFi SSID, and enter the password below. (In order to avoid input errors, after the input is completed, you can click the eye pattern on the right to check whether the password is entered correctly).

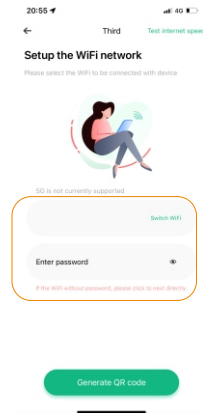

Enter the WiFi SSID and password below

Attention:
5G is not currently supported

7. Scan QR code to Add Devices

Put the network configuration QR code at a distance of about 30cm from the upper camera, and the camera will give a voice prompt after scanning, click "Heard the device prompt".

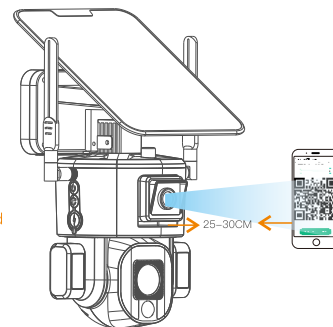

7.APP Homepage Instructions

8.Homepage Function

Introduction of camera's functions in the home page.

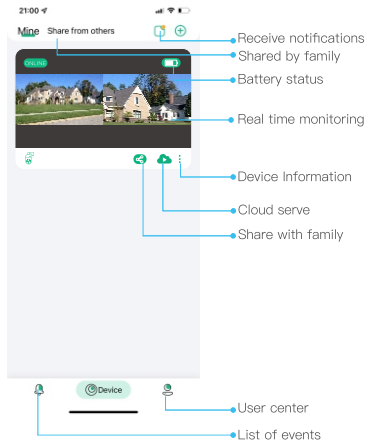

9.Sharing Function

After your family has registered the account, click to share with them.

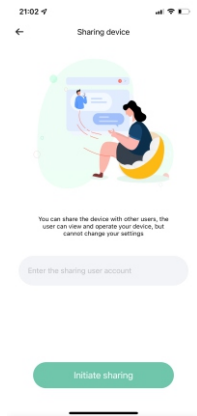

10.Do not Disturb Mode

At the top of the page Enter the Do Not Disturb mode setting. When PIR is triggered, you will get the notifications in the real time. If you do not want to receive notifications, you can turn on Do Not Disturb mode.

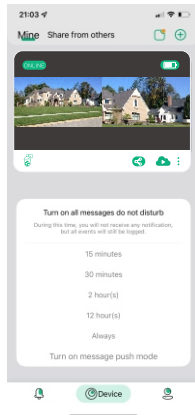

11.Viewing the Event List

Click "Event" at the bottom of the page to enter the event list to view the alarm list of the device.

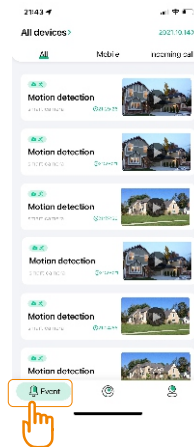

12.Cloud Storage Service

Click at the homepage to purchase the cloud storage packages.

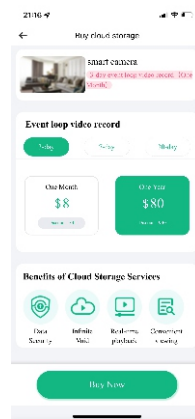

13.Manage Account Information

Click "Mine" at the bottom of the page to enter the APP page, you can modify the login password and manage all functions.

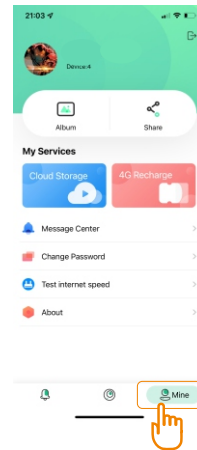

8.Real-time Monitoring and Play back

14.Real-time Monitoring

Click the screen on the homepage to access real-time monitoring

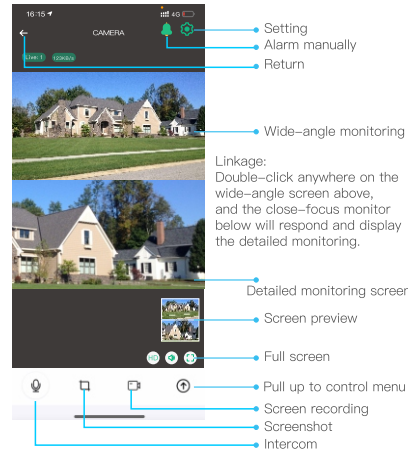

15.Video Playback of Memory Card

Click the video playback button on the homepage of the pull-up control menu to enter playback, select memory card playback.

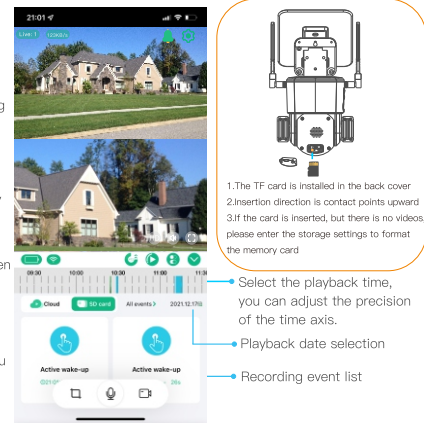

16.Video Playback of Cloud Storage

Click the video playback button on the homepage of the pull-up control menu to enter playback, select cloud storage playback.

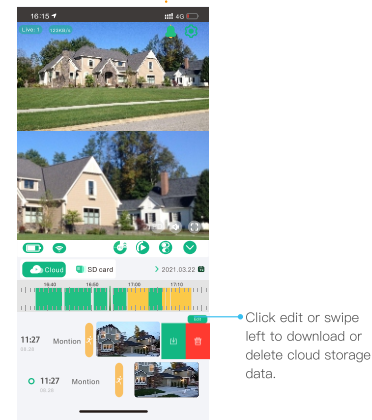

9.Control Instructions

17.PTZ Control

Click the pull-up menu to enter the control page, Click the to control the PTZ camera.

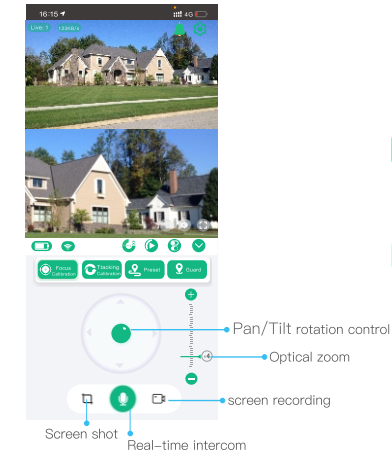

Focus Calibration:

When the camera is optical zoom version, if the focus is not clear due to changes in the monitoring environment, you can click to enter the calibration mode. The calibration takes two minutes.

Tracking Calibration:

When there is a difference in the rotation direction of the camera's pan/tilt, you can click the reset, and the camera's pan/tilt will self-detect and calibrate the position of the pan/tilt.

Preset:

When the user has multiple fixed-point to monitoring, can control the PTZ to the position that requires fixed-point monitoring and save the reserved position for quick positioning.

Guard:

When human tracking is turned on, the camera will follow the human figure to rotate. Set the guard position to ensure that your key position can be monitored at any time. The setting method is to control the PTZ to your key monitoring point and click the guard position.

10.Intelligent Tracking and Linkage

18.Intelligent Tracking and Linkage

Click  in the interface to select the humanoid tracking.

Click  in the interface to select the Linkage mode

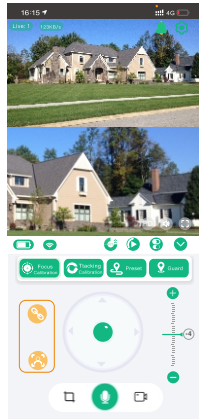
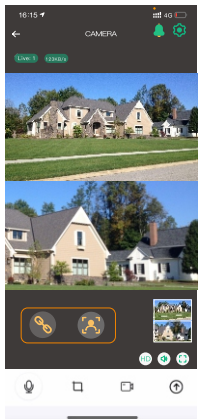

Humanoid tracking function:

The green is the off state, and the yellow is the on state.

Turning on the humanoid tracking, when the PTZ camera detects a humanoid, it will automatically track.



Linkage function:

The green is the off state, and the yellow is the on state.

Tuning on the linkage function, the human shape will be judged by the upper wide-angle camera, and the PTZ camera will be linked for pan-tilt tracking. When double-clicking any position on the wide-angle screen, the lower focus monitor will be positioned.

11.System Settings

19.Quick Settings

Click  to enter the camera quick settings.

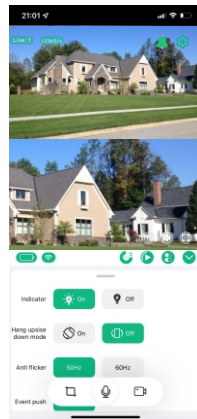

20. Device Information

Click  to enter device information, check firmware version and upgrade.

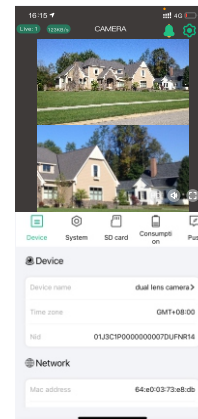

21.System Settings

Click  to enter system settings, change the camera's displaymode and other system settings.

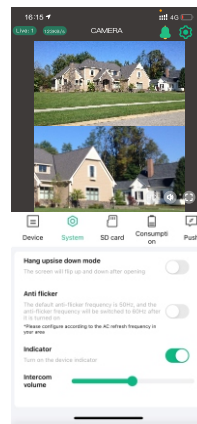

22.Memory card Settings

Click  to enter memory card settings, you can check its usage status and format.

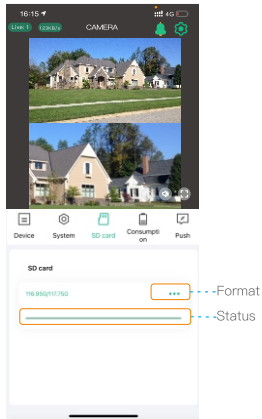

23.Alert Push Settings

Click  to enter the push settings of the camera, select the information to be accepted according to your needs.

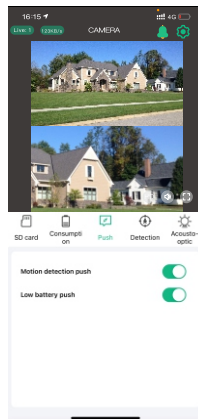

24.Detection Settings

Click  to enter camera motion detection settings, you can set the sensitivity and detection distance adjustment.

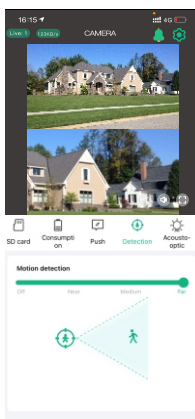

25.Power Consumption

Click  to enter power management, select the use mode according to the environment and user needs, which can better manage the use of the battery.

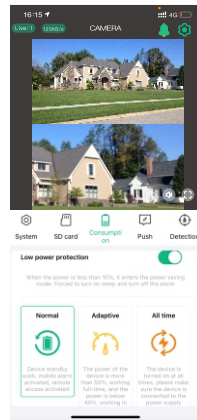

Low power protection:

It is recommended to turn on this function. When the power of the camera is lower than 10%, the camera will automatically turn off PIR and other power-consuming functions.

 Normal mode:

It is the most energy-saving and efficient working mode. When the mobile phone is not remotely monitored, the camera is in standby mode. When a human body passes by, it will automatically activate the alarm and video record and push to the mobile APP at the same time.

 Adaptive mode:

When the power is more than 50%, it will start recording at full time. If lower than 40%, it will work on standby.

 All time mode:

The camera is working at all times, please make sure to connect the power supply to charge in this mode.

26.Sound & light settings

Click  to enter camera sound and light settings, setting working mode of infrared led, white lights and alarm.

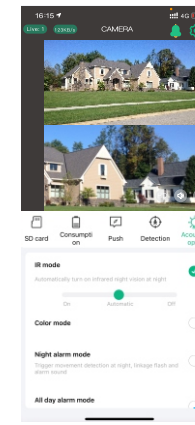

 Infrared leds control

 White lights are on at night, camera video is full color.

 At night, when human passes by, the white lights flash and sound alarm.

 All day alarm mode, when human passes by, the white lights flash and sound alarm.

11. Wall Mounted Installation Instructions

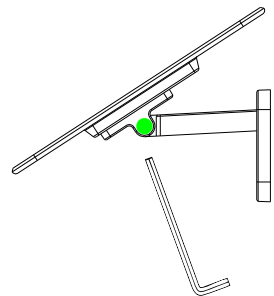

- 1** Fix the solar panel and the bracket together by hexagonal wrench, and adjust it to the maximum sunlight orientation according to the installation environment.

- 2** Connect the solar panel charging port.

3

Use screws to secure the iron wall bracket on the wall, hang the camera from top to bottom, finally lock the tamper-proof screws below.

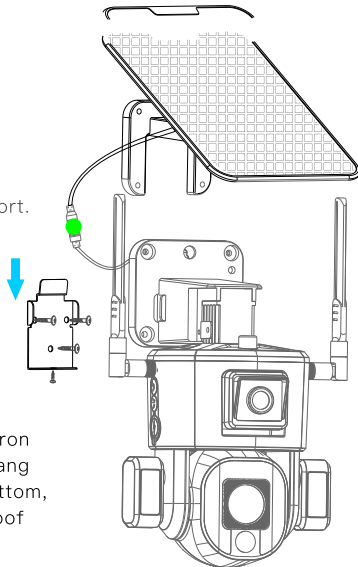

12. Ceiling Mounted Installation Instructions

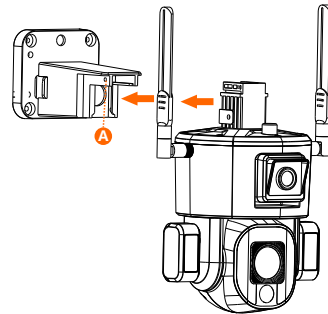

- 1** Unscrew the fixing screw at A, and then pull out the upper wall bracket.

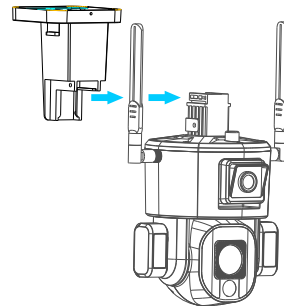

- 2** Put the upper wall bracket upright, insert it along the rail and fix the screws.

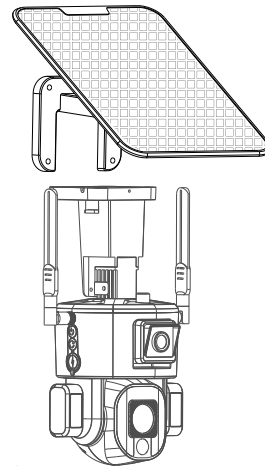

13..Commissioning Instructions

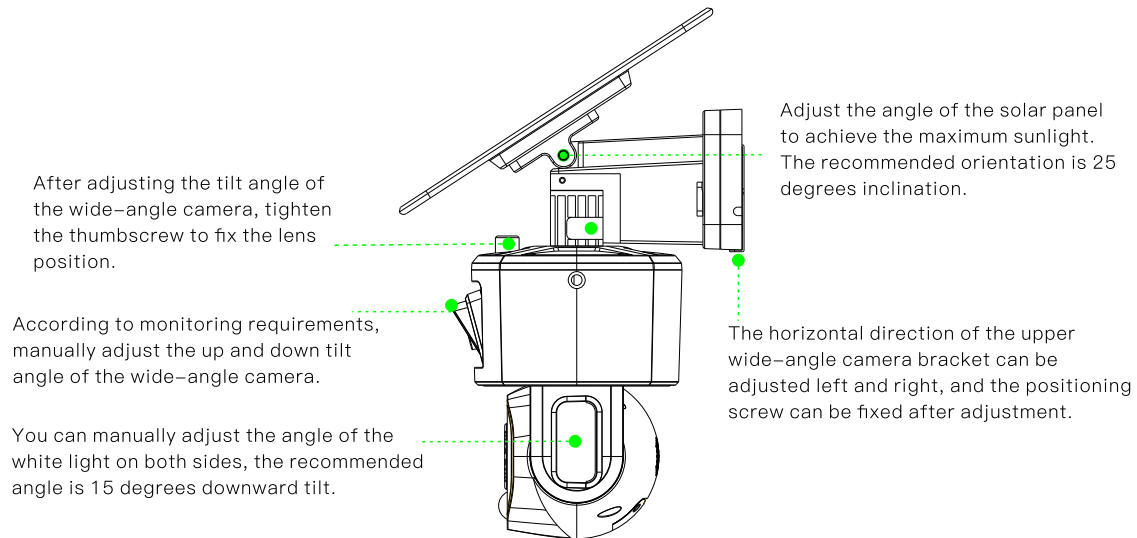

14.Technical Analysis

1. Q:Why doesn't the Wi-Fi name appear when I connect to Wi-Fi?

A: On IOS devices with iOS13 and above, you need to turn on the "location permission" for the app in the system settings and change it to "allow when using".

2. Q:Will the camera show red lights when night vision is activated?

A: The built-in infrared leds make the camera only show some dim red lights when night vision is activated, but the image quality is still clear under no light environment.

3. Q: How far should the device be from the router?

A: After testing, the Wi-Fi connection distance can normally reach up to 220 meters in the open area. However, the actual situation depends on the strength of Wi-Fi and its surrounding environment (thick walls, electromagnetic devices, large metal objects will all cause interference to the Wi-Fi signals). If the camera connection signal is weak or unstable, please place the camera as close to the router as possible.

4. Q: What is the longest recording time?

A: The camera has three working modes.

The default mode is low power consumption mode. When someone passes by, the camera will automatically start recording for 15 seconds. When the person is in the monitoring range, the camera will keep recording. The built-in battery of the camera can work for 6000 wake-ups, and the solar energy supplements 250 wake-ups per hour. In theory, it can be used all the time. The second mode is the adaptive mode. When the battery is above 50%, the camera will record 24 hours. When the power is below 45%, the low-power working mode is turned on. When someone passes by, the camera will automatically start recording for 15 seconds. When the person is in the monitoring range, the camera will keep recording. The third mode is the full-time mode. In this mode, a continuous power supply is required. At full power, if there is no power supply, it can only work for 36 hours.

Technical Analysis

5. Q:How to check the video playback?

A: Click the video playback button on the homepage of the pull-up control menu ,select memory card playback or cloud storage playback.

6. Q: Do I need to always connect my mobile device to any WiFi if I'd like to watch the videos?

A:No, you don't. You can use WLAN or Cellular Data to watch them only if your camera is well connected to your router's WiFi.

7. Q: What will happen when the memory card runs out of space?

A:The oldest footage will be overwritten by the latest one. Please back up the important videos timely or delete the unnecessary videos to release more space. Alternatively, you can subscribe to a cloud plan.

8. Q: What should I do if the WiFi connection failed?

A:

* Please make sure your camera is connecting to a 2.4GHz WiFi, not a 5GHz WiFi.

* Move the camera and your mobile device closer to your router when connecting.

* Check if the WiFi password you entered was wrong or if there are special symbols in the password.

* Make sure the power of your camera is enough and your router did not disconnect power.

9. Q: Why does the camera disconnect to WiFi sometimes?

A:

* Please check the network connection of your mobile device and the router.

* If the camera can't receive a strong signal, please try to move your router closer to the camera, or use a WiFi extender.

* Make sure the power of your camera is enough and your router is connected to power.

10. Q: How many cameras can I connect to the same account?

A: You can add 50 cameras, but we recommend adding up to 10 devices for a better experience.

Technical Analysis

12. Q: How many accounts can a camera share with?

A: 8 accounts.

About batteries and solar power

This camera adopts advanced low-power technology. If no motion is detected, the camera will enter sleep mode.

After being fully charged, if the camera contains a 20000mAh battery, it can be awakened 6000 times by detecting human movement. If it works for 15 seconds at a time and is charged by solar energy, when the sun is full, the replenished power can be used for 300 wake-ups per hour.

Tips:

If the camera is woken up frequently or detects the movements of human body for many times, the power of the camera will be consumed quickly. Charging the camera regularly is recommended. The battery in the camera can be charged for 500 times. If we charge the camera once a week, the life span of the battery can extend more than 9 years.

The recommended operating temperature of the camera is 14°F~122°F(-10°C~50°C). Battery performance may drop at low temperatures. At -4°F(-20°C), the battery may drain in short time, or even may not charge. It will work normally as the temperature rises.